

Interactive Adapter search:
www.mactoolsradiatortools.com

SCAN
THIS CODE



CST500

Includes 3 Most Commonly Required
Cooling System Adapters



MAR300

Refiller,
Pressure Tester and
Coolant Retainer all in one!



CSR202

For Use with Positive
Fit Cooling System Adapters

Higher Vacuum!
**Faster, more
complete fill!**



CSR302

No Adapters Required!

APPLICATION GUIDE and PARTS LIST for
COOLING SYSTEM ADAPTERS and COOLING SYSTEM TOOLS

MAR
TOOLS

COOLING SYSTEM TOOLS FOR LARGE TRUCKS



CSR400 Large Truck Refiller

- New higher capacity generator creates a high vacuum quickly.
- Larger internal passageways to move more coolant faster
- Longer and larger hoses improve coolant flow
- Faster, more complete fill on larger systems

CSR400

Truck Refiller sized specifically for large trucks

CST300 Large Truck Cooling System Pressure Tester:

1. Pressure pump uses shop air to generate pressure in large truck cooling systems EFFORTLESSLY!
2. Set includes 3 adapters to pressure test pressure relieving caps found on large trucks. The UCT700-6 cap adapter tests caps from "A" size (2 3/16" O.D.) filler necks. The RCA14504 cap adapter tests caps from "B" size (2 11/16" O.D.) filler necks. The RCA1C035 cap adapter tests caps with a 52mm x 2.5mm thread.



Combine **CST300** with **CSA600** for complete truck cooling system testing with no duplications.

CSA600 Large Truck Cooling System Adapter Set:

Compatible with most cooling system pressure tester pumps. Includes 6 cooling system adapters:

- | | |
|-------------|-------------|
| (1) RA14505 | (4) RA10022 |
| (2) RA10036 | (5) RA10054 |
| (3) RA10027 | (6) RA10032 |

NOTE: Plastic box available separately #CSA600PB



Vacuum Holding Adapters

Large trucks often have two colling system caps located on the expansion tank: an accessible, non-pressure relieving cap and a pressure relieving cap that will leak under vacuum (normally found on the side of the tank).

RA10052V



50 x 2.5 mm

RA10022V



45 x 3 mm

RA10025V



48 x 3 mm

RA10036V



52 x 2.5 mm

In order to put the cooling system under vaccumn to service the cooling system, a vaccumn-holding adapter may be necessary. These adapters replace the pressure-relieving cap during the process and have an automatic safety pressure-relief system in case it is accientally left on.

The CSR400 large truck refiller is in a case that is designed with 4 molded recesses to store these adapters with the tool.

RA10022



RCA1C023



WHERE GASKET OF CAP SEALS ON COOLANT BOTTLE NECK

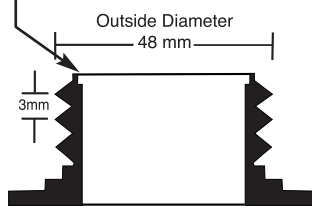

Thread Cutaway

APPLICATION:

AUDI®: models with male threads on filler neck
PORSCHE®:
Boxster: 1997-2006
Cayman: 2006
911: 2000-2012
SMART CAR®:
Models 2008-2015
VOLKSWAGEN®: models with male threads on filler neck of radiator or expansion tank-pre 1990.

RA10025



RCA1C026



WHERE GASKET OF CAP SEALS ON COOLANT BOTTLE NECK

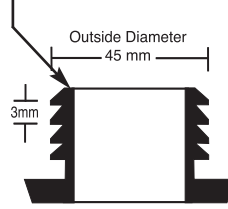

Thread Cutaway

APPLICATION:

FERRARI®/MASERATI®: most models 2000-current
JEEP®: models with male threads on filler neck (1990-1994)
RENAULT®: (1985-1997)
SAAB® 900: (1978-1993)
-900 Convertible (1994)
-9000 (1986-1998)
STERLING®: (1987-1991)
VOLVO®: most models through 2007 with threaded neck (see page 18)

RA10031



RCA1C030



WHERE O-RING OF CAP SEALS ON COOLANT BOTTLE NECK

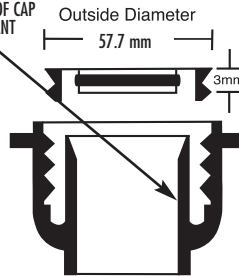

Thread Cutaway

APPLICATION:

VOLKSWAGEN®:
Most models with female threads on filler neck 1990-1998

RA10032

RCA1C035



WHERE GASKET OF CAP SEALS ON COOLANT BOTTLE NECK

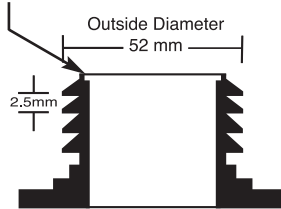

Thread Cutaway

APPLICATION:

Some models of Buick®, Cadillac®, Chevrolet®, Ford®, Freightliner®, GMC®, International®, Infiniti®, Isuzu®, Jaguar®, Kenworth®, Land Rover®, Lincoln®, Mazda®, Mercedes-Benz®, Mercury®, Nissan®, Oldsmobile®, Peterbilt® and Pontiac®.

RCA1C047



RA10034



WHERE GASKET OF CAP SEALS ON COOLANT BOTTLE NECK

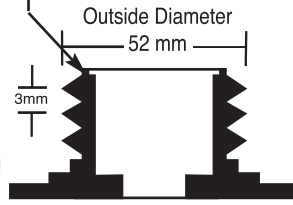

Thread Cutaway

APPLICATION:

Some models of Cadillac®, Chevrolet®, Daewoo®, Ford®, Jaguar®, Land Rover®, Pontiac®, Saab®, Saturn® and Suzuki®

RCA1C035



RA10036



WHERE O-RING OF CAP SEALS ON COOLANT BOTTLE NECK

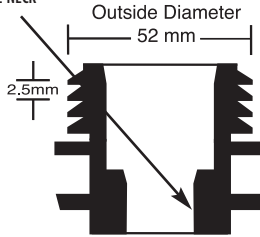

Thread Cutaway

APPLICATION:

Some models of Buick®, Cadillac®, Chevrolet®, Dodge®, Ford®, Freightliner®, GMC®, Hummer®, International®, Infiniti®, Isuzu®, Jaguar®, Jeep®, Land Rover®, Lincoln®, Mazda®, Mercedes-Benz®, Mercury®, Nissan®, Pontiac®, RAM®, Saab®, Saturn® and Suzuki®

RA10041



RCA1C040



WHERE O-RING OF CAP SEALS ON COOLANT BOTTLE NECK

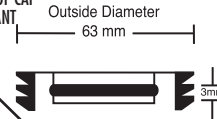

Thread Cutaway

APPLICATION:

AUDI®: A4 1996-current
A6 1998-current
A8 1997-current
S4 2004-current
TT 2000-current
BENTLEY®: 2006-current
LAMBORGHINI®: 2006-current
PORSCHE®: Boxster 2007-2013
Cayenne 2003-2013
Cayman 2007-2011
Macan 2015-current
Panamera 2010-current
VW®: most models, 1998 and newer

RCA1C045



RA10044



WHERE O-RING OF CAP SEALS ON COOLANT BOTTLE NECK

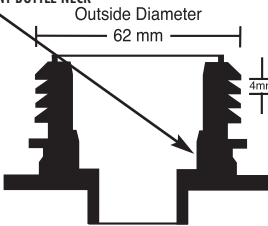

Thread Cutaway

APPLICATION:

MERCEDES-BENZ®: with threaded filler neck on expansion tank (except M-class, 1998-2005) (see page 16)
Sprinter Van 2019-current

CHRYSLER®:

Crossfire 2004-2008

RCA1C047



RA10046



WHERE O-RING OF CAP SEALS ON COOLANT BOTTLE NECK

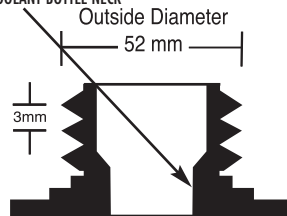

Thread Cutaway

APPLICATION:

Some models of Aston Martin®, Ford®, Jaguar® and Mazda®

RCA1C049



RA10048



WHERE O-RING OF CAP SEALS ON COOLANT BOTTLE NECK

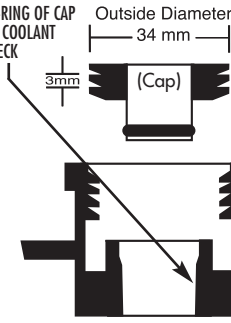

APPLICATION:

- LEXUS®:**
 - LS 2007 - current
- LOTUS®** Some Models
- TOYOTA®:**
 - Calica 2000-current
 - Spyder (MR2) 2000-current
 - RAV4 2009-current
 - Hybrid Synergy Drive
- Cooling System:**
 - Prius 2004-current
 - Camry 2007-current
 - Highlander 2006-current
- SCION®:**
 - XB, 2008-current

RCA1C053



RA10052



WHERE O-RING OF CAP SEALS ON COOLANT BOTTLE NECK

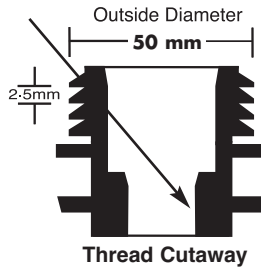

APPLICATION:

- ASTON MARTIN®:**
 - 6.0L, V-12
 - 2015-current
- FORD®:**
 - Many of the newer models (2011 and newer) will take the RA10052. See page 13 and 14 for specific models.
- LAND ROVER®:**
 - LR-2 2008-current
 - Range Rover
 - Evoque 2012-current
- MAZDA®:**
 - Mazda 3 2004-current
- VOLVO®:**
 - most models 2004-current

RCA1C057



RA10056



WHERE O-RING OF CAP SEALS ON COOLANT BOTTLE NECK

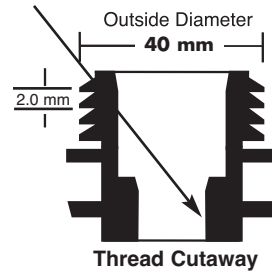

APPLICATION:

- Supercharger Cooling Systems
- CADILLAC®:**
 - STS, ATS, CTS 2006-current
- CHEVROLET®:**
 - Bolt 2017-current
 - Cobalt SS 2005-2007
 - Volt 2012-current
- CHRYSLER®:**
 - Pacifica Hybrid 2017-current
- SATURN®:**
 - Ion Redline 2004-2007

RCA1C059



RA10058



WHERE O-RING OF CAP SEALS ON COOLANT BOTTLE NECK

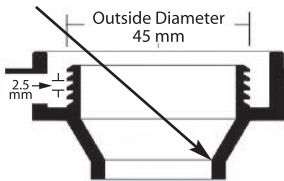

APPLICATION:

- DODGE®:**
 - Sprinter Van 2007-2010
- MERCEDES-BENZ®:**
 - Sprinter Van 2011-2018
 - A-Class 2019 - current
 - B-Class 2015 - current

RCA1C026



RA10063



WHERE GASKET OF CAP SEALS ON COOLANT BOTTLE NECK

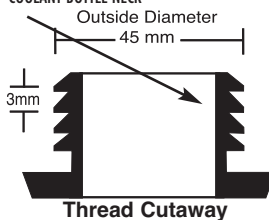

APPLICATION:

- BMW®:**
 - Turbocharger Cooling Systems (all)
 - INFINITI®:**
 - QX 50 2019 - current
 - MINI®**
 - Cooper 2002-current
 - SMART CAR®:**
 - 2016-current
- Comment: The RA10063 seals with an o-ring just like the cap from the system it tests. In most cases, the RA10025, which seals on the top rim will adequately seal such that pressure testing can be accomplished.*

**KTM® MOTORCYCLES
BAYONET STYLE
ADAPTER**



RA10067

RA10067R

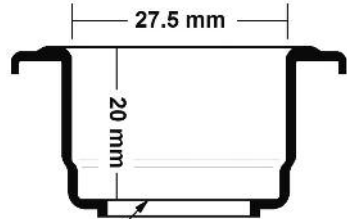

WHERE GASKET SEALS ON RADIATOR NECK

**KTM® MOTORCYCLES
THREADED ADAPTER**



RA10069

WHERE GASKET OF CAP SEALS ON RADIATOR NECK

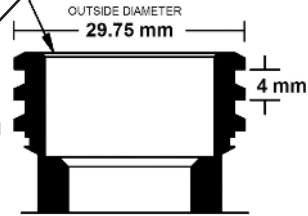

**APRILIA® MOTORCYCLES
THREADED ADAPTER**



RA10070

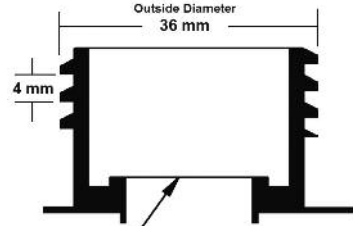

WHERE GASKET SEALS ON COOLANT SYSTEM NECK

RA10072



WHERE GASKET OF CAP SEALS ON COOLANT BOTTLE NECK

RCA1C026

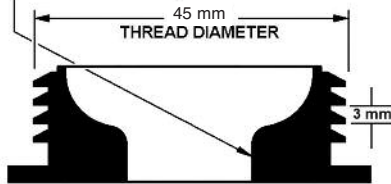

COOLING SYSTEM TANK
THREAD CUTAWAY

Comment: The RA10072 seals with an o-ring just like the cap from the system it tests. In most cases, the RA10025, which seals on the top rim will adequately seal such that pressure testing can be accomplished

APPLICATION:

- ALFA ROMEO®:**
Some models with threaded filler necks
- FERRARI®:**
2015 - current
- FIAT®:**
Model 500: Some versions with threaded filler necks
- MASERATI®:**
Ghibli S Q4
2015-current
- RAM®:**
ProMaster
2015-current

RA10074



RCA1C023

WHERE O-RING OF CAP SEALS ON COOLANT BOTTLE NECK

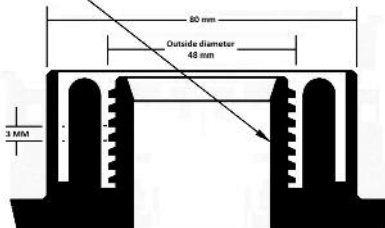

APPLICATION:

- BENTLEY®:**
Some Models
- VOLKSWAGEN®:**
Sharan (EU)
Phaeton 2004-2006 (US)



RA10078

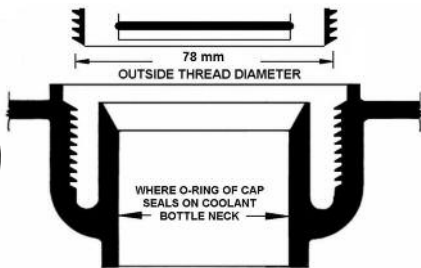

APPLICATION:

PORSCHE®:

- Boxster
- 2015 - current
- Cayman
- 2014 - current
- (found in luggage compartment)



RCA1C087



RA10086



WHERE GASKET OF CAP SEALS ON COOLANT BOTTLE NECK

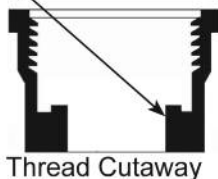

Thread Cutaway

APPLICATION:

HYUNDAI®:

- Some sub-models of Elantra, Ioniq, Kon and Tucson

KIA®:

- Some sub-models of Niro, Seltos, Soul and Sportage
- See page 14 (for HYUNDAI®) and 15 (for KIA®) for more specific applications



RCA1C089

RA10088



WHERE O-RING OF CAP SEALS ON COOLANT BOTTLE NECK

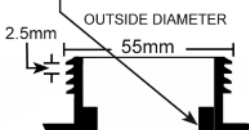

APPLICATION:

VOLVO®:

- XC40 2018 - current
- XC90T8 Hybrid-2016-current



RA10093



RA10092



Left Hand Thread

WHERE RA10093 SEALS FOR VACUUM REFILLING
WHERE RA10092 SEALS FOR PRESSURE TESTING
52mm OUTSIDE DIAMETER

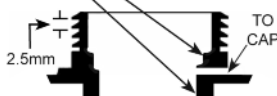

APPLICATION:

- CHEVROLET®: Silverado with Duramax® Engine: 2017-2019

- GMC® Sierra pick-up with Duramax® engine 2017-2019

- Use RA10092 for pressure testing.
- Use RA10093 for vacuum refilling.



RA10098



RCA1C099

WHERE O-RING OF CAP SEALS IN COOLANT BOTTLE NECK

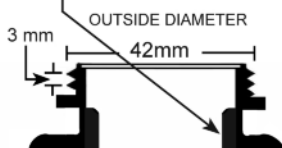

APPLICATION:

TESLA®:

- Tesla Model 3
- Model Y



RA10104



RCA1C0105



WHERE GASKET OF CAP SEALS ON COOLANT BOTTLE NECK

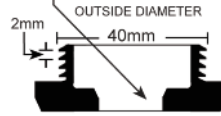

APPLICATION:

HYUNDAI®:

Some sub-models of Santa Fe and Tucson

KIA®:

Some sub-models of Sorento. See page 14 (for HYUNDAI®) and 15 (for KIA®) for more specific applications



RA10106



RCA1C0107



WHERE GASKET OF CAP SEALS ON COOLANT BOTTLE NECK

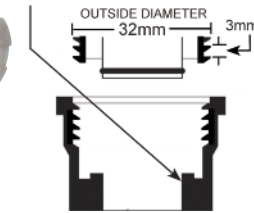

APPLICATION:

HYUNDAI®:

Some sub-models of Santa Fe and Tucson

KIA®:

Carnival and K5 and some sub-models of Sorento and Sportage. See page 14 (for HYUNDAI®) and 15 (for KIA®) for more specific applications.



RA10110

Left Hand Thread



RCA10111

WHERE GASKET OF CAP SEALS ON COOLANT BOTTLE NECK

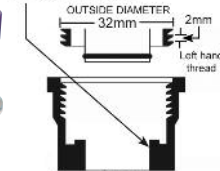

APPLICATION:

HYUNDAI®:

Ioniq Electric and Kona Electric

KIA®:

Niro Hybrid and Plug-in. See page 14 (for HYUNDAI®) and 15 (for KIA®) for specific applications

RCA1C047



RA10245



WHERE GASKET OF CAP SEALS ON COOLANT BOTTLE NECK

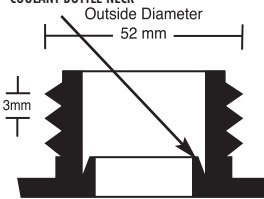

APPLICATION:

BMW®: models with threaded filler necks (up to 1987)

325: up to 1991

525: up to 1993

MERKUR® SCORPIO: (1987-1989)

Comments: Rubber gasket seals on "shelf" inside expansion tank neck

RCA1C346



RA10345



WHERE GASKET OF CAP SEALS ON COOLANT BOTTLE NECK

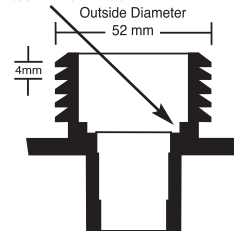

APPLICATION:

BMW®: Most Models, 1998-2008

LAND ROVER®:

Some models with male threads on filler neck (see page 15)

Discovery 1999-2004

Range Rover 1996-2006

Comments: Rubber gasket seals on "shelf" inside expansion tank neck

RCA1C446



RA10445



WHERE GASKET OF CAP SEALS ON COOLANT BOTTLE NECK

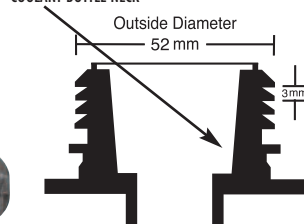

APPLICATION:

BMW®:

Most BMW models, 2007-current

3-Series 2006-current

5-Series 2005-current

6-Series 2005-current

X3 2009-current

X5 2009-current

X6 2008-current

TOYOTA®:

Supra 2020 - current

MOST ASIAN VEHICLES - MOTORCYCLES - FORKLIFTS - TOYOTA® SIENNA VAN

Remote adapter allows pressure pump or vacuum refiller to be installed in various low overhead applications.

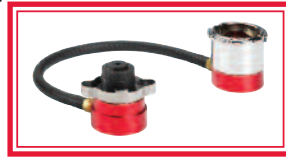

RA10128R

Most motorcycles, including the Harley Davidson® liquid cooled models, use this configuration.



RCA1C029



RA10128

ROUNDED EARS

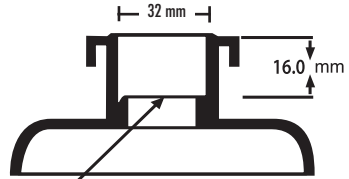

WHERE GASKET OF CAP MEETS RADIATOR NECK



RCA1C039



RA10138

SQUARE EARS

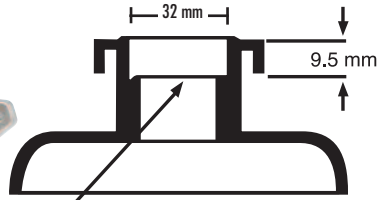

WHERE GASKET OF CAP MEETS RADIATOR NECK

Comments: The RA10128/RCA1C029 and the RA10138/RCA1C039 have applications too numerous to list here. See Application Guide pp 12-18. These adapter sets are quite similar, but the RA10128/RCA1C029 is a deeper neck than the RA10138/RCA1C039. See drawings above, right.

Note: RA10128 AND RA10138 are shaped to resemble caps from system to be tested.



UCT700-4

UCT700-6

WHERE GASKET OF CAP MEETS RADIATOR NECK

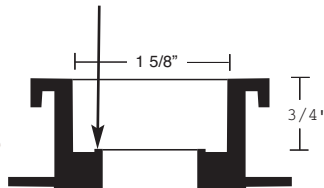

APPLICATION:

Most passenger vehicles through the mid 1980's have this radiator neck and many still do today. This is the configuration onto which the pump attaches directly.

LARGE TRUCKS / BUSES / HEAVY EQUIPMENT

RCA1C023



RA10022

WHERE GASKET OF CAP SEALS ON COOLANT BOTTLE NECK

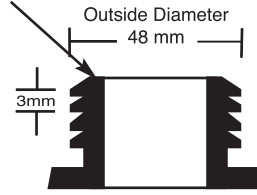

APPLICATION:

MACK® TRUCKS:
2008 and later with
48mm x 3mm threads
on filler neck

VOLVO®:

Large Trucks with
48mm x 3mm male
thread on filler neck

RA10027



WHERE GASKET OF CAP SEALS ON COOLANT BOTTLE NECK

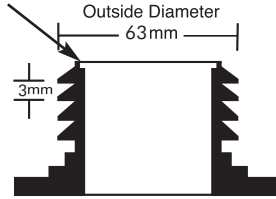

APPLICATION:

VOLVO®:

Large Trucks with
63mm x 3mm thread
on filler neck



RA10042



WHERE GASKET OF CAP SEALS ON COOLANT BOTTLE NECK

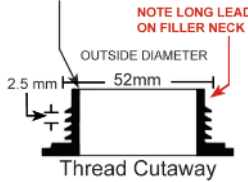

APPLICATION:

KENWORTH®:

T660 and T680 Trucks

RA10054



WHERE GASKET OF CAP SEALS ON COOLANT BOTTLE NECK

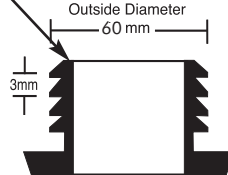

APPLICATION:

FREIGHTLINER®:

Trucks with
60mm x 3mm male
thread on filler neck



RA10076



Note: Cap and
adapter have 3 tabs

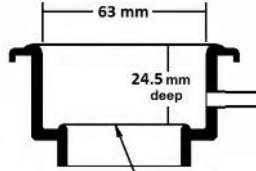

WHERE GASKET OF CAP SEALS ON COOLANT SYSTEM NECK

APPLICATION:

LIEBHERR® CRANE:

Some models

VAN HOOÏ® BUS:

Some models



RA10084



WHERE GASKET OF CAP SEALS ON COOLANT BOTTLE NECK

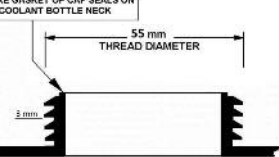

COOLING SYSTEM TANK
THREAD CUTAWAY

APPLICATION:

KENWORTH®:

2015-current

T270

T370

LARGE TRUCKS / BUSES / HEAVY EQUIPMENT



RA10090

Note: Cap and adapter have 3 tabs



WHERE GASKET OF CAP SEALS ON COOLANT BOTTLE NECK

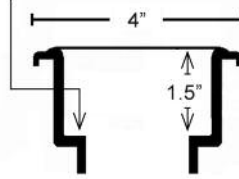

APPLICATION:
INDUSTRIAL
APPLICATIONS:
With a 4 inch neck

RCA14504



RA14505
Type cap

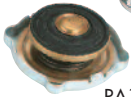

RA14505



RA14505 and RCA14504:
Adapters for trucks with "B" size
2 11/16" O.D. filler neck

WHERE GASKET OF CAP MEETS RADIATOR NECK (RA14503)

WHERE GASKET OF CAP MEETS RADIATOR NECK (RA14505)

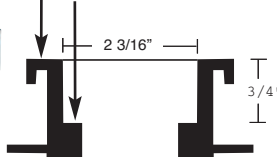

Thread Cutaway



RA14503
Type cap

RA14503



PART #RA14503: GM adapter tests pressure on "closed cooling systems" on GM 2.5L "X" body cars and 1.8L "J" body cars



RA10094



WHERE GASKET OF CAP SEALS ON COOLANT BOTTLE NECK

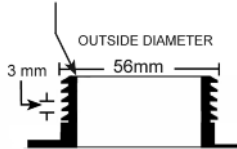

Thread Cutaway

APPLICATION:

VOLVO®:

Volvo FH4 trucks and
A45G Haul Trucks



RA10096



WHERE GASKET OF CAP SEALS ON COOLANT BOTTLE NECK

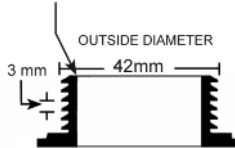

Thread Cutaway

APPLICATION:

MACK®

with 6.7L Cummins engine
VOLVO®:
Volvo EC220E Excavator



RA10102



WHERE GASKET OF CAP SEALS ON COOLANT BOTTLE NECK

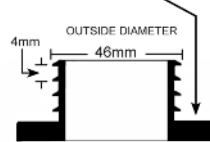

Thread Cutaway

APPLICATION:

JOHN DEERE®:

Some John Deere tractors



RA10108

WHERE GASKET OF CAP SEALS ON COOLANT BOTTLE NECK

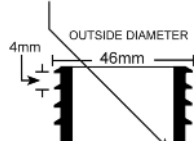

Thread Cutaway

APPLICATION:

FENDT® 900 series,
1000 series and
1100 series

COOLING SYSTEM ADAPTERS

Interactive Adapter search:
www.mactoolsradiatorstools.com

Make/Model/Year	Cooling System Adapter	Cap Adapter
ACURA®		
Models with 16mm deep filler neck, see page 9	RA10128	RCA1C029
Models with 9.5mm deep filler neck, see page 9	RA10138	RCA1C039
ALFA ROMEO®		
Some models 2014-current	RA10072**	RCA1C026
ASTON MARTIN®		
6.0L, V-12 2015-current	RA10052	RCA1C05
Various Models 2005-current	RA10046	RCA1C047
AUDI®		
Models with male threads on filler neck of exp. tank	RA10022	RCA1C023
Models with female threads on filler neck of exp. tank	RA10041	RCA1C040
BLUEBIRD® BUS		
Late model Thomas Built buses	RA10036	RCA1C035
BMW®		
Models with threaded filler neck		
Up to 1987	RA10245	RCA1C047
1988 & Newer, (except as noted)	RA10345	RCA1C346
Most models after 2006	RA10445	RCA1C446
Model 325		
1988-1991	RA10245	RCA1C047
Model 535		
1989-1993	RA10245	RCA1C047
5&6 Series		
2005-current	RA10445	RCA1C446
1 Series		
2008-current	RA10445	RCA1C446
3 Series		
1990-2006	RA10345	RCA1C346
2005-current	RA10445	RCA1C446
Turbocharger cooling sys (all)	RA10063▲	RCA1C026
5 Series		
1998-2004	RA10345	RCA1C346
2005-current	RA10445	RCA1C446
Turbocharger cooling sys (all)	RA10063▲	RCA1C026
6 Series		
2004-current	RA10445	RCA1C446
Turbocharger cooling sys (all)	RA10063▲	RCA1C026
7 Series		
1994-2008	RA10345	RCA1C346
2008-current	RA10445	RCA1C446
Turbocharger cooling sys (all)	RA10063▲	RCA1C026

Make/Model/Year	Cooling System Adapter	Cap Adapter
BMW®		
X1 2009-2011	RA10345	RCA1C346
X3 2004-7/2009 7/2009	RA10345 RA10445	RCA1C346 RCA1C446
X5 2000-2008 2009-current Turbocharger cooling sys (all)	RA10345 RA10445 RA10063▲	RCA1C346 RCA1C446 RCA1C026
X6 2008-current Turbocharger cooling sys (all)	RA10445 RA10063▲	RCA1C446 RCA1C026
Z3 2002	RA10345	RCA1C346
Z4 2003-2008 2009-current	RA10345 RA10445	RCA1C346 RCA1C446
Z8 2003	RA10345	RCA1C346
BUICK®		
All Models w/male threads on filler neck except as noted below	RA10036*	RCA1C035
Skyhawk 1982-1987 1.8L & 2.0L	RA14503	
Skylark 1982-1988 2.5L 1992-1998	RA14503 RA10036*	RCA1C035
Somerset 1985-1987 2.5L	RA14503	
CADILLAC®		
All Models w/male threads on filler neck except as noted below	RA10036*	RCA1C035
Catera 1997-2001	RA10034	RCA1C047
STS, CTS, ATS 2005-current Engine Cooling System Supercharger Cooling System	RA10036 RA10056	RCA1C035 RCA1C057

**RA10025 may also work.

▲RA10063 seals the same way the radiator cap seals but the RA10025 will work in most applications.

*If RA10036 "Stem" with O-ring will not fit into cooling system neck, the RA10032 may be required.

COOLING SYSTEM ADAPTERS

Interactive Adapter search:
www.mactoolsradiatorstools.com

Make/Model/Year	Cooling System Adapter	Cap Adapter
CHEVROLET®		
All Models w/male threads on filler neck except as noted below	RA10036*	RCA1C035
Aveo 2004-2011	RA10034	RCA1C047
Beretta 1992-1996	RA10036*	RCA1C035
Bolt 2017-current	RA10056	RCA1C057
Citation 1982-1985 2.5L RA10056	RA14503 RCA1C057	
Cobalt 2005-2010 Engine Cooling System Supercharger Cooling System	RA10036 RA10056	RCA1C035 RCA1C057
Impala 1994-1996 2004-current	RA10036* RA10036	RCA1C035 RCA1C035
Lumina 1990-1992	RA14503	
Metro 1998-2001	RA10138	RCA1C039
Nova 1985-1988	RA10128	RCA1C029
Prizm 1998-2002	RA10138	RCA1C039
Silverado with Duramax (LSP diesel) engine 2017-2019 (pressure testing) 2017-2019 (vacuum filling)	RA10092 RA10093	
Spectrum 1985-1989	RA10128	RCA1C029
Sprint 1985-1988	RA10128	RCA1C029
Tracker 1998-2004	RA10138	RCA1C039
Volt 2012-current Electric Motor Battery System Gasoline Engine	RA10056 RA10056 RA10036	RCA1C057 RCA1C057 RCA1C035
CHRYSLER®/DODGE®/EAGLE®/PLYMOUTH®/RAM®		
200 2015-current	RA10036	RCA1C035
1500 with eTorque 2018 - current	RA10056	RCA1C057
2000 GTX 1989-1990	RA10128	RCA1C029
Avenger 1995-1999	RA10128	RCA1C029
Colt 1984-1993 1992-1994 (some models)	RA10128 RA10138	RCA1C029 RCA1C039
Conquest 1984-1989	RA10128	RCA1C029
Crossfire 2004-2008	RA10044	RCA1C045
Dart 2013-current	RA10036	RCA1C035
Laser/Talon 1990-1998	RA10128	RCA1C029

Make/Model/Year	Cooling System Adapter	Cap Adapter
CHRYSLER®/DODGE®/EAGLE®/PLYMOUTH®/RAM®		
Pacifica 2017-current Engine Cooling System Electric Motor	RA10036 RA10056	RCA1C035 RCA1C057
Promaster 2014-current	RA10072**	RCA1C026
RAM 50 Pickup 1987-1993	RA10128	RCA1C029
RAM 1500 1991-current	none	UCT700
RAM 1500 with eTorque 2018-current	RA10056	RCA1C057
RAM Pickup (threaded cap on expansion tank) 2013-current	RA10036	RCA1C035
Sebring 2003-2005 6c 3.0L & 4c 2.4L 2001, 2002-2006	RA10138 none	RCA1C039 UCT700-6
Sprinter Van 2007-2010	RA10058	RCA1C059
Stealth 1991-1996	RA10128	RCA1C029
Stratus (3.0 liter only) 2001-2006	RA10138	RCA1C039
Summit 1989-1992 1992-1996	RA10128 RA10138	RCA1C029 RCA1C039
Talon 1990-1998	RA10128	RCA1C029
DAEWOO®		
All 1999-2002	RA10034	RCA1C047
FENDT®		
Series 900, 1000 and 1100	RA10108	
FERRARI®		
Most Models 2000-current	RA10025	RCA1C026
FIAT®		
500 2015-current	RA10072**	RCA1C026
FORD®/LINCOLN®/MERCURY®		
All Models w/male threads on filler neck except as noted below	RA10036*	RCA1C035
Aspire 1994-1997	RA10128	RCA1C029
C-Max 2013-current	RA10052	RCA1C053
Contour 1995-1997 1998-2000	RA10034 RA10046	RCA1C047 RCA1C047
Cougar/Thunderbird 1989-1992 1993-1997 V8 1993-1997 V6	RA10128 RA10036* RA10128	RCA1C029 RCA1C035 RCA1C029
Ecosport 2013-current	RA10052	RCA1C053
Edge 2015-current	RA10052	RCA1C053

**RA10025 will work in most applications

* If RA10036 "Stem" with O-ring will not fit into cooling system neck, the RA10032 may be required.

COOLING SYSTEM ADAPTERS

Interactive Adapter search:
www.mactoolsradiatorstools.com

Make/Model/Year	Cooling System Adapter	Cap Adapter
FORD®/LINCOLN®/MERCURY®		
Escape		
2001-2012	RA10046	RCA1C047
2013-current	RA10052	RCA1C053
Escort/Tracer		
1991-2012	RA10128	RCA1C029
Explorer/Mountaineer/Aviator		
1995-2002	RA10128	RCA1C029
2002-current	RA10036*	RCA1C035
F Series pick-up		
2015-current	RA10052	RCA1C053
Festiva		
1988-1993	RA10128	RCA1C029
Fiesta		
2011-current	RA10052	RCA1C053
Focus		
2000-2004	RA10034	RCA1C047
2005-2007	RA10036*	RCA1C035
2008-2011	RA10128	RCA1C029
2012-current	RA10052	RCA1C053
Fusion		
2006-2012	RA10036*	RCA1C035
2013-current	RA10052	RCA1C053
LS		
2002-2006	RA10034	RCA1C047
MKC		
2015-current	RA10052	RCA1C053
Mustang		
V8, 1996-2014	RA10036*	RCA1C035
V6, 1997-2004	RA10128	RCA1C029
V6, 2005-2014	RA10036*	RCA1C035
V6 and V8 2015-current	RA10052	RCA1C053
Probe		
1989-1997	RA10128	RCA1C029
Ranger Pickup		
1995-current (non threaded neck)	RA10128	RCA1C029
2002-current (threaded neck)	RA10036*	RCA1C035
Super Duty Pick-up		
2012-current expansion tank Intercooler	RA10032 RA10128	RCA1C035 RCA1C029
Tempo/Topaz		
1992-1994	RA10128	RCA1C029
Thunderbird		
1989-1993 (All)	RA10128	RCA1C029
1994-1997 (V6)	RA10128	RCA1C029
1994-1997 (V8)	RA10036*	RCA1C035
2002-2004 (V8)	RA10036*	RCA1C035
Transit Connect		
2010-2012	RA10034	RCA1C047
2013-current	RA10052	RCA1C053
Villager		
1993-2002	RA10128	RCA1C029
Windstar		
1995-2000	RA10128	RCA1C029
2000-2003	RA10036*	RCA1C035
ZX2		
2001-2003	RA10128	RCA1C029

* If RA10036 "Stem" with O-ring will not fit into cooling system neck, the RA10032 may be required.

Make/Model/Year	Cooling System Adapter	Cap Adapter
FREIGHTLINER®		
Trucks with: 60mm x 3mm male thread 52mm x 2.5mm male thread	RA10054	
Cascadia		
2007-current	RA10032	RCA1C035
Century, Columbia		
2002-current	RA10036	RCA1C035
GEO®		
Metro		
1989-1994	RA10128	RCA1C029
1995-1998	RA10138	RCA1C039
Prizm		
1989-1992	RA10128	RCA1C029
1993-2002	RA10138	RCA1C039
Storm		
1990-1993	RA10128	RCA1C029
Tracker		
1989-1993	RA10128	RCA1C029
1994-2004	RA10138	RCA1C039
GMC®		
All Models w/male threads on filler neck	RA10036	RCA1C035
Sierra w/ Duramax engine		
2017-2019 (pressure testing)	RA10092	
2017-2019 (vacuum filling)	RA10093	
2020-current	RA10036 RA10056	RCA1C035 RCA1C057
HONDA®		
Models with 16mm deep filler neck, see page 9	RA10128	RCA1C029
Models with 9.5mm deep filler neck, see page 9	RA10138	RCA1C039
HUMMER®		
All Models w/male threads on filler neck	RA10036	RCA1C035
HYUNDAI®		
Models with non-threaded cap	RA10128	RCA1C029
Elantra		
2016-current	RA10086	RCA1C0087
Ioniq, Electric		
2020	RA10110	RCA1C111
Ioniq		
2017-2019	RA10086	RCA1C087
Kona, Electric		
2019-2020	RA10110	RCA1C111
Kona (gasoline)		
2020	RA10086	RCA1C087
Sante Fe		
2021-current	RA10104	RCA1C105
Santa Fe, Hybrid		
2021-current	RA10106	RCA1C107
Tucson 2.0L & 2.4L		
2016-current	RA10086	RCA1C087
Tucson 2.5L		
2022-current	RA10106	RCA1C107
Tucson Hybrid		
2022-current	RA10106	RCA1C107
Tucson, non-hybrid		
2022-current	RA10104	RCA1C105

COOLING SYSTEM ADAPTERS

Interactive Adapter search:
www.mactoolsradiatortools.com

Make/Model/Year	Cooling System Adapter	Cap Adapter
INDUSTRIAL		
Various industrial applications (see page 11 for specs)	RA10090	
INTERNATIONAL®		
466 Engine with male threads on filler neck 1994-1998	RA10032	RCA1C035
INFINITI®		
All Models with Non-Threaded Small Cooling System Caps (see page 9)	RA10128	RCA1C029
QX30 2017-current	RA10044	RCA1C045
QX50 2019 - current	RA10063	RCA1C026
QX56 2004-2009 2010-current	RA10036* RA10128	RCA1C035 RCA1C029
ISUZU®		
All models except as noted below 1985-2009	RA10128	RCA1C029
Amigo 1999-2000 (L-4 only)	RA10138	RCA1C039
Ascender 2002-2009	RA10036	RCA1C035
i280 2006	RA10036	RCA1C035
i290 2007-2008	RA10036	RCA1C035
i350 2006	RA10036	RCA1C035
i370 2007-2008	RA10036	RCA1C035
Oasis 1996-1999	RA10138	RCA1C039
Rodeo 1998-2003 (L-4 only)	RA10138	RCA1C039
JAGUAR®		
Models with male threads on filler neck 1990-1994	RA10034	RCA1C047
E-Pace 2018-current	RA10052	RCA1C053
F-Type 2013-current	RA10036	RCA1C035
XF 2009-current	RA10036*	RCA1C035
XJ8 1998-2003 2004-2009	RA10046 RA10036*	RCA1C047 RCA1C035
XK8 1997-2004, 2006	RA10046	RCA1C047
S-Type 2000-2008	RA10036*	RCA1C035
X-Type 2002-2009	RA10034	RCA1C047

Make/Model/Year	Cooling System Adapter	Cap Adapter
JEEP®		
Models with male threads on filler neck 1987-1990	RA10025	RCA1C026
Cherokee 2014-current	RA10036	RCA1C035
Renegade 2015-current	RA10036	RCA1C035
Wrangler 2018-current with eTorque	RA10036	RCA1C035
2018-current	RA10056	RCA1C057
JOHN DEERE® TRACTORS		
Most model #'s over 3000 with 48mm O.D. male threads on filler neck	RA10022	RCA1C023
Some model #'s over 3000 with 52mm O.D. male threads on filler neck	RA10102	N/A
Some Models	RA10102	
KENWORTH® TRUCKS		
Some Models 2007-current T270, T370	RA10032	RCA1C035
2015-current T660	RA10084	
2008-2017 T680	RA10042	
2014-current	RA10042	
KIA®		
Models with non-threaded cap Carnival	RA10128	RCA1C029
2022-current K5	RA10106	RCA1C107
2021-current Niro EV	RA10106	RCA1C107
2019-current Niro Hybrid & Plug-in	RA10110	RCA1C111
2017-current Seltos 1.6L	RA10086	RCA1C087
2021-current Sorento	RA10086	RCA1C087
2021-current Sorento Hybrid	RA10104	RCA1C105
2021-current Soul 1.6L	RA10106	RCA1C107
2021-current Sportage 2.0L & 2.4L	RA10086	RCA1C087
2021-current Sportage 2.5L	RA10106	RCA1C107
2022-current	RA10106	RCA1C107

* If RA10036 "Stem" with O-ring will not fit into cooling system neck, the RA10032 may be required.

COOLING SYSTEM ADAPTERS

Interactive Adapter search:
www.mactoolsradiatortools.com

Make/Model/Year	Cooling System Adapter	Cap Adapter
LAND ROVER®		
Defender 1993-1995, 1997	RA10034	RCA1C047
Discovery 1998 1999-2004	RA10034 RA10345	RCA1C047 RCA1C346
Freelander 2002-current	RA10025	RCA1C026
LR2 2008-current	RA10052	RCA1C053
LR3 2005-2009	RA10036*	RCA1C035
LR4 2010-2016	RA10036*	RCA1C035
Range Rover 1988-1994 1995-2005 2006-2015	RA10034 RA10345 RA10036*	RCA1C047 RCA1C346 RCA1C035
Range Rover Evoque 2012-current	RA10052	RCA1C053
Velar 2018-current	RA10032	RCA1C035
LEXUS®		
Models with 16mm deep filler neck, see page 9	RA10128	RCA1C029
Models with 9.5mm deep filler neck, see page 9	RA10138	RCA1C039
Models with Threaded Caps:		
GS 460 2008-2011	RA10048	RCA1C049
HS 250h 2010-current	RA10048	RCA1C049
IS F 2008-2014	RA10048	RCA1C049
LS 2007-current	RA10048	RCA1C049
NX 2015-current	RA10048	RCA1C049
LIEBHERR® CRANE		
Some models	RA10076	
MACK®		
Late models with male threads on filler neck w/6.7L Cummins engine	RA10022	RCA1C023
2022-current	RA10096	
MASERATI®		
Most Models 2000-current	RA10025	RCA1C026
Ghibli S Q4 2015-current	RA10072**	RCA1C026
MAZDA®		
Models with 16mm deep filler neck, see page 9	RA10128	RCA1C029
Models with 9.5mm deep filler neck, see page 9	RA10138	RCA1C039
Models with Threaded Caps:		
B2300 Pickup 1994-1997	none	UCT700-6
2001-2009	RA10036*	RCA1C035
Tribute 2001-2011	RA10046	RCA1C047
Mazda 3 2004-current	RA10052	RCA1C053
Mazda 6 2003-current	RA10036	RCA1C035

Make/Model/Year	Cooling System Adapter	Cap Adapter
McLAREN®		
Most Models 2012-current	RA10072	RCA1C026
MERCEDES-BENZ®		
Models with threaded neck except M-Class below	RA10044	RCA1C045
A-Class 2019-current	RA10058	RCA1C059
B-Class 2015-current	RA10058	RCA1C059
M-Class with threaded neck 1998-2005	RA10036*	RCA1C035
M-Class 2006-current	RA10044	RCA1C045
Sprinter 2018-current 2019-current	RA10058 RA10044	RCA1C059 RCA1C045
MERKUR®		
Scorpio 1987-1989	RA10245	RCA1C047
MINI®		
Cooper S Model 2002-current	RA10063▲	RCA1C026
MITSUBISHI®		
Models with 16mm deep filler neck, see page 9	RA10128	RCA1C029
Models with 9.5mm deep filler neck, see page 9	RA10138	RCA1C039
NISSAN®		
All models with non-threaded small cooling system caps 1987-current	RA10128	RCA1C029
Armada/Titan 2004-2009 2010-2015	RA10036* RA10128	RCA1C035 RCA1C029
Kicks 2019-current	RA10063	RCA1C026
Rogue Sport 2017-current	RA10063	RCA1C026
Rogue 2021-current	RA10063	RCA1C026
OLDSMOBILE®		
Achieva 1992-1998	RA10036*	RCA1C035
Alero 1999-2004	RA10036	RCA1C035
Aurora 1995-1999	RA10036*	RCA1C035
Bravada 2002-2004	RA10036	RCA1C035
Cutlass 1997-1998 1999-2004	RA10036* RA10036	RCA1C035 RCA1C035
Intrigue 1999-2002	RA10036*	RCA1C035

▲ RA10063 seals the same way the radiator cap seals but the RA10025 will work in most applications.

* If RA10036 "Stem" with O-ring will not fit into cooling system neck, the RA10032 may be required.

**RA10025 will work in most applications

COOLING SYSTEM ADAPTERS

Interactive Adapter search:
www.mactoolsradiatortools.com

Make/Model/Year	Cooling System Adapter	Cap Adapter
PETERBILT® TRUCKS		
Some Models 2007-current	RA10032	
PONTIAC®		
Fiero		
1984-1988	RA14503	
Firebird		
1999-2002	RA10036	RCA1C035
G3		
2009-2010	RA10034	RCA1C047
G5		
2007-2012	RA10036	RCA1C035
G6		
2005-2010	RA10036	RCA1C035
Grand Am		
1985-1988	RA14503	
1992-2005	RA10036*	RCA1C035
Grand Prix		
2004-2008	RA10036	RCA1C035
GTO		
2004-2008	RA10036*	RCA1C035
Le Mans		
1988-1993	RA10034	RCA1C047
Montana		
1999-2006	none	UCT700-6
2007-2009	RA10036	RCA1C035
Optima		
1988-1991	RA10036*	RCA1C035
Solstice		
2006-2009	RA10036	RCA1C035
Sunbird		
1982-1992	RA14503	
Sunburst		
1985-1988	RA10128	RCA1C029
Sunfire		
1995-1998	RA10036*	RCA1C035
1999-2005	RA10036	RCA1C035
Vibe		
2003-2013	RA10138	RCA1C039
PORSCHE®		
911		
1999-current	RA10022	RCA1C023
Boxster		
1997-2006	RA10022	RCA1C023
2007-2013	RA10041	RCA1C040
2015-current	RA10078	
(in luggage compartment)		
Cayenne		
2003-current	RA10041	RCA1C040
Cayman		
2006	RA10022	RCA1C023
2007-2011	RA10041	RCA1C040
2014-current	RA10078	
(in luggage compartment)		
Macan		
2015-current	RA10041	RCA1C040
Panamera		
2010-current	RA10041	RCA1C040
RENAULT®		
All models		
1985-1987	RA10025	RCA1C026

Make/Model/Year	Cooling System Adapter	Cap Adapter
ROLLS ROYCE®		
Ghost		
2010	RA10445	RCA1C446
Engine cooling system		
Supercharger cooling system	RA10063	RCA1C026
SAAB®		
900		
1978-1993	RA10025	RCA1C026
1994-1998	RA10034	RCA1C047
900 Convertible		
1994	RA10025	RCA1C026
9000		
1986-1998	RA10025	RCA1C026
9-3		
1999-2003	RA10034	RCA1C047
2004-2011	RA10036	RCA1C035
9-5		
1999-2008	RA10034	RCA1C047
9-7X		
2005-2009	RA10036*	RCA1C035
SATURN®		
All models except as below		
1990-1998	RA10036*	RCA1C035
1999-2010	RA10036*	RCA1C035
L - Series		
2000-2005	RA10034	RCA1C047
Vue		
2002	RA10034	RCA1C047
2003-2009	RA10036	RCA1C035
Ion Redline		
Engine Cooling System	RA10036	RCA1C035
Supercharger Cooling System	RA10056	RCA1C057
SCION®		
All models except below		
XB	RA10128	RCA1C029
2008	RA10048	RCA1C049
SMART CAR®		
All models except below:		
2008-2015	RA10022	RCA1C023
2016-current	RA10063	RCA1C026
STERLING®		
All models		
1987-1991	RA10025	RCA1C026
SUBARU®		
Models with 16mm deep filler neck, see page 9	RA10128	RCA1C029
Models with 9.5mm deep filler neck, see page 9	RA10138	RCA1C039
SUZUKI®		
Models with 16mm deep filler neck	RA10128	RCA1C029
Models with 9.5mm deep filler neck EXCEPT BELOW:	RA10138	RCA1C039
Forenza		
2004-2008	RA10034	RCA1C047
Reno		
2005-2008	RA10034	RCA1C047
Verona		
2004-2006	RA10034	RCA1C047
XL7		
2007-2009	RA10036	RCA1C035

* If RA10036 "Stem" with O-ring will not fit into cooling system neck, the RA10032 may be required. PAGE 17

COOLING SYSTEM ADAPTERS

Interactive Adapter search:
www.mactoolsradiatortools.com

Make/Model/Year	Cooling System Adapter	Cap Adapter
TESLA®		
Model 3 2017-current	RA10098	RCA1C099
Model S 2012-current	RA10036	RCA1C035
Model Y 2020-current	RA10098	RCA1C099
TOYOTA®		
Models with Non-Threaded Cooling System Caps: Models with 16mm deep filler neck, see page 9 Models with 9.5mm deep filler neck, see page 9	RA10128 RA10138	RCA1C029 RCA1C039
Models with Threaded Cooling System Caps: Celica 2000-2005	RA10048	RCA1C049
MR2 Spyder 2000-2005	RA10048	RCA1C049
RAV4 1996-2008 2009-current	RA10138 RA10048	RCA1C039 RCA1C049
Sienna, see page 9 1998-2006 2007-current	RA10128R RA10138	RCA1C029 RCA1C039
Supra 2020-current	RA10445	RCA1C446
Hybrid Synergy Drive Cooling System: Camry 2007-current	RA10048	RCA1C049
Corolla 2020-current	RA10048	RCA1C049
Highlander 2006-current	RA10048	RCA1C049
Prius 2004-current	RA10048	RCA1C049
TRUCKS/HEAVY DUTY		
Vehicles with large fill ("B") neck (2 11/16") see page 10	RA14505	RCA14504
VAN HOOL® BUS		
Some models	RA10076	
VOLKSWAGEN®		
Models with male threads on filler neck 1975-1993	RA10022	RCA1C023
Arteon 2019-current	RA10041	RCA1C040
Atlas 2018-current	RA10041	RCA1C040
Beetle 1998-current	RA10041	RCA1C040
CC 2009-2017	RA10041	RCA1C040
Cabrio 1995-2002	RA10031	RCA1C030

Make/Model/Year	Cooling System Adapter	Cap Adapter
VOLKSWAGEN®		
Corrado 1990-1994	RA10031	RCA1C03
Eurovan 1993-2003	RA10031	RCA1C030
Golf 1991-1999 2000-current	RA10031 RA10041	RCA1C030 RCA1C040
GTI 1991-1999 2000-current	RA10031 RA10041	RCA1C030 RCA1C040
Jetta 1991-1999 1999-current	RA10031 RA10041	RCA1C030 RCA1C040
Passat 1990-1997 1998-current	RA10031 RA10041	RCA1C030 RCA1C040
Phaeton 2002-2006	RA10074	RCA1C023
Touareg 2004-current	RA10041	RCA1C040
VOLVO®		
All with threaded neck except large trucks and as specified below	RA10025	RCA1C026
C30 2008-current	RA10052	RCA1C053
C70 2008-current	RA10052	RCA1C053
S40 2004-2011	RA10052	RCA1C053
S60 2011-current	RA10052	RCA1C053
S80 2008-current	RA10052	RCA1C053
V50 2005-2011	RA10052	RCA1C053
V60 2014-current	RA10052	RCA1C053
V70 2008-2010	RA10052	RCA1C053
XC40 2018-current	RA10088	RCA1C089
XC60 2010-current	RA10052	RCA1C053
XC70 2008-current	RA10052	RCA1C053
XC90 T8 Hybrid 2016-current Engine Cooling System Battery Cooling System	RA10052 RA10088	RCA1C053 RCA1C089
Volvo® Large Trucks with: 48mm x 3mm thread 63mm x 3mm thread	RA10022 RA10027	RCA1C023
Volvo® Heavy Equipment A45G Articulated Hauler 2017-current EC220E Excavator	RA10094 RA10096	

Laminated adapter application sheet
included with both the CSA1700
and CSA1700A.

• FITS RIGHT INSIDE THE CASE •

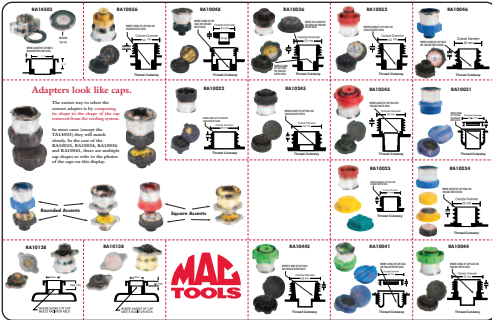

Plastic case
available
separately #CSA1700PB

CSA1700 COMPLETE AUTOMOTIVE COOLING SYSTEM TESTER:

CSA1700 will pressure test the cooling systems of all modern cars and light trucks through 2017. Includes UCT700-8 pump and the following 17 adapters: RA10022, RA10025, RA10031, RA10034, RA10036, RA10041, RA10044, RA10046, RA10048, RA10052, RA10056, RA10128, RA10138, RA10245, RA10345, RA10445, and RA14503.

Does not cover 2007 - 2018 Sprinter Van, Kia, Hyundai or hybrid Volvo.

The **CSA1700A** is the above set of cooling system adapters without the UCT700-8 pump. If you are interested in a complete set of **CAP** adapters, see page 20.

CSCA1700: 17 PIECE COOLING SYSTEM CAP ADAPTER SET



- * *Compatible with most pressure pumps on the market.*
- * *17 Adapters (some multi purpose) test the 20 different pressure relieving CAPS found on cooling systems today.*
- * *Adapters, where possible, are shaped to resemble the caps that they test, for example:*



RCA1C023

RCA1C053

Adapters Included in the set are: RCA1C023, RCA1C026, RCA1C029, RCA1C030, RCA1C035, RCA1C039, RCA1C040, RCA1C045, RCA1C047, RCA1C049, RCA1C053, RCA1C057, RCA1C059, RCA1C346, RCA1C446, RCA14504, UCT700-6.

COOLING SYSTEM ADAPTER GASKET APPLICATION GUIDE

(Use gasket part # when ordering replacement gaskets)

ADAPTER	GASKET/O-RING SIZE	GASKET PART #
RA10034, RA10036	1 7/8" O.D. x 1 3/16" I.D. x 1/8" thick	RA10036G
RA10245, RA10345	1 7/16" O.D. x 15/16" I.D. x 1/16" thick	RA10345G
RA10128, RA10138	1 1/8" O.D. x 1/2" I.D. x 1/4" thick	RA10128G
RA10031, RA10041, RA10074	36mm O.D. x 28mm I.D. x 4mm cross section O-ring	RA10041R
RA10032, RA10042	1 7/8" O.D. x 1 1/16" I.D. x 1/8" thick	RA10032G
RA10036, RA10046, RA10052, RA10088, RA10092	31mm O.D. x 23mm I.D. x 4mm cross section O-ring	RA10036R
RA10044	42mm O.D. x 34mm I.D. x 4mm cross section O-ring	RA10044R
RA10048	13/16" O.D. x 5/8" I.D. x 3/32" cross section O-ring (O-ring # P16)	RA10048R
RA10056, RA10098	23mm O.D. x 17mm I.D. x 3mm cross section O-ring	RA10056R
RA10058	27mm O.D. x 21mm I.D. x 3mm cross section O-ring	RA10058R
RA10445	38mm O.D. x 28mm I.D. x 5mm cross section O-ring	RA10445R
RA14503	2 3/4" O.D. x 1 3/4" I.D. x 3/16" thick	RA14502
RA14505	Molded Rubber Gasket	RA14501
RA10025, RA10096	1 11/16" O.D. x 1 1/16" I.D. x 1/8" thick	RA10025G
RA10022	1 3/4" O.D. x 1" I.D. x 1/8" thick	RA10022G
RA10027	2 3/8" O.D. x 1 5/8" I.D. x 1/8" thick	RA10027G
RA10054	2 1/4" O.D. x 1 1/2" I.D. x 1/8" thick	RA10054G
RA10063, RA10078	1 7/16" O.D. x 1 3/16" I.D. x 1/8" cross section O-ring	RA10063R
RA10067, RA10067R	Molded Rubber Gasket	RA10067G
RA10069	1" O.D. x 5/8" I.D. x 3/16" thick	RA10069G
RA10070	1" O.D. x 1/2" I.D. x 1/16" thick	RA10070G
RA10072	26mm O.D. x 19mm I.D. x 3.5mm cross section O-ring	RA10072R
RA10076	Molded Rubber Gasket (custom)	RA10076G
RA10084, RA10094	2 1/16" O.D. x 1 1/8" I.D. x 1/8" thick	RA10084G
RA10086	21mm O.D. x 14mm I.D. x 3.5mm cross O-ring	RA10086R
RA10090	Molded Rubber Gasket (custom)	RA10090G
RA10093	27mm O.D. x 19mm ID x 4mm cross section O-ring	RA10093R
RA10096	1 1/2" O.D. x 1" I.D. x 1/8" thick	RA10096G
RA10102	2 3/8" O.D. x 2" I.D. x 3/16" cross (#329)	Consult Factory

MAR300 COOLANT PRESSURE TESTER, REFILLER AND RETAINER

- PARTS DIAGRAM AND REPLACEMENT PART NUMBERS -

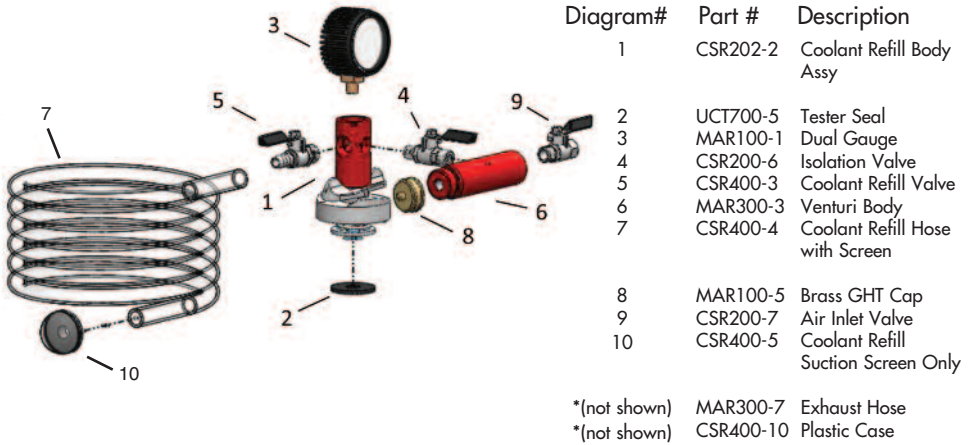

CST300 PARTS LIST

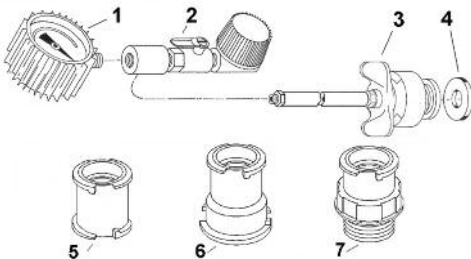
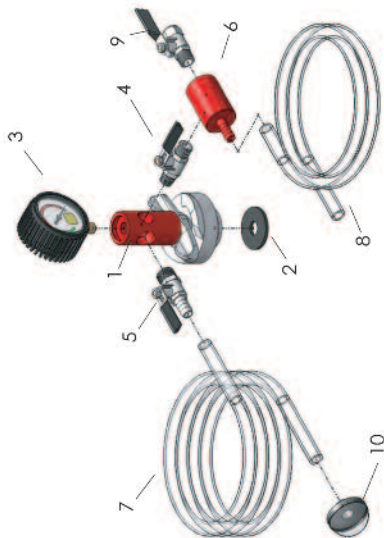

Diagram #	Stock Part #	Description
Not Shown	UCT700-7	Plastic Carrying Case
*	CST300-1	Complete Pump w/Gauge & Hose Assy. (1-4)
1	UCT700-1	Pressure Gauge only
2	CST300-2	Valve Regulator Assy.
3	CST300-3	Tester Head w/Hose Assembly
4	UCT700-5	Tester Seal
5	UCT700-6	Cooling System Cap Adapter (A-size)
6	RCA14504	Cooling System Cap Adapter (B-size)
7	RCA1C035	Cooling System Cap Adapter (52mm x 2.5mm)

CSR202 & CSR302



ITEM	PART #	DESCRIPTION
*	CSR200-10	PLASTIC CASE (not shown)
3	CSR202-1	VACUUM GAUGE, LOWER CONNECT
4	CSR200-6	ISOLATION VALVE
5	CSR202-3	COOLANT REFILL VALVE
6	CSR200-8	VENTURI BODY ASSEMBLY
7	CSR200-4	COOLANT REFILL HOSE W/SCREEN
8	CSR200-9	OVERFLOW HOSE
9	CSR200-7	AIR INLET VALVE
10	CSR200-5	COOLANT REFILL SUCTION SCREEN ONLY
CSR202 ONLY		
1	CSR202-2	COOLANT REFILL BODY ASSEMBLY
2	UCT700-5	TESTER SEAL
CSR302 ONLY		
11	CSR-302-2	COOLANT REFILL BODY ASSEMBLY
12	CSR302-4	ADAPTER CONE, SMOOTH
13	CSR302-3	ADAPTER CONE, STEP

CSR400 Truck Refiller

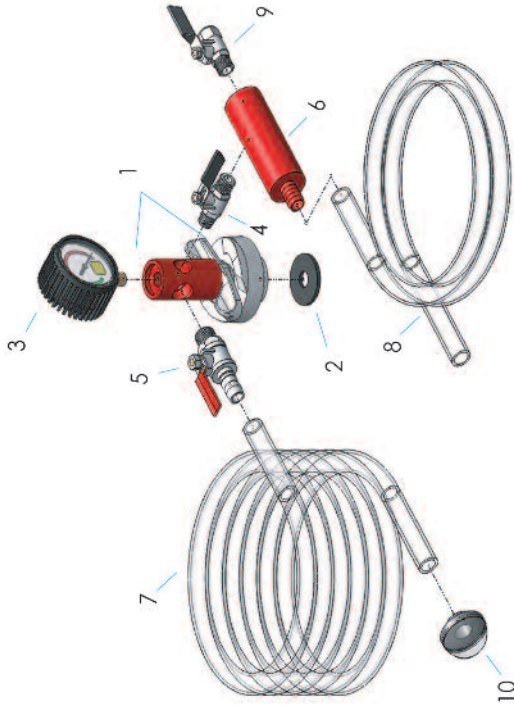

ITEM	PART #	DESCRIPTION
1	CSR202-2	COOLANT REFILL BODY ASSEMBLY
2	UCT700-5	TESTER SEAL
3	CSR202-1	VACUUM GAUGE, LOWER CONNECT
4	CSR200-6	ISOLATION VALVE
5	CSR400-3	COOLANT REFILL VALVE
6	CSR400-8	VENTURI BODY ASSEMBLY
7	CSR400-4	COOLANT REFILL HOSE W/SCREEN
8	CSR400-9	OVERFLOW HOSE
9	CSR200-7	AIR INLET VALVE
10	CSR400-5	COOLANT REFILL SUCTION SCREEN ONLY
*	CSR400-10	PLASTIC CASE

	Maximum Vacuum (inHg)	Flow (CFM)	Air consumption (CFM)	Refill Rate (Gal/Min)
CSR202	28.3	2.4	5.8	2.8
CSR302	28.3	2.4	5.8	2.8
CSR400	28.3	5.8	15.5	4.8
MAR300	28.1	8.1	17	4.8

Test performed using 100 - 110psi compressed air

Barometric pressure: 30.1 - 30.2

(For best results use 100psi regulated pressure input)



NOTES:

CST500 Cooling System Tester

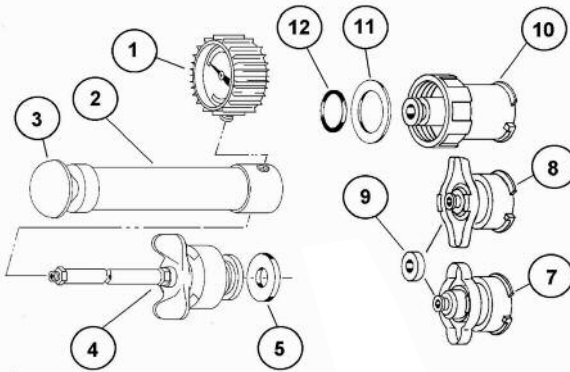

DIAGRAM #	STOCK PART#	DESCRIPTION
*	UCT700-8	Cooling System Tester Pump (Diagram #1-5) - Packed in a cardboard box.
not shown	UCT700-7	Plastic Carrying Case
1	UCT700-1	Heavy Duty Pressure Gauge with Rubber Boot
2	UCT700-2	Pump Assembly with Knob (gauge not included)
3	UCT700-3	Knob Only
4	UCT700-4	Tester Head with Hose Assembly NOTE: Hose may be field repaired - use 3/16" ID fuel hose
5	UCT700-5	Tester Seal
7	RA10128	32 mm x 16mm deep Radiator Adapter with Seal, Silver
8	RA10138	32 mm x 9.5mm deep Radiator Adapter with Seal, Gold
9	RA10128G	Rubber Seal for 32mm Radiator Adapters
10	RA10036	Radiator Adapter
11	RA10036G	Rubber Seal for #RA10036
12	RA10036R	Rubber O-Ring for #RA10036

CAUTION: TO AVOID PERSONAL INJURY AND/OR VEHICLE DAMAGE – While some precautions are specified in this manual, and should be noted to avoid personal injury or vehicle damage, it is not possible for these cautions to cover all conceivable ways in which service or testing might be done, or all possible hazardous consequences of each way, nor could Mac Tools® possibly know or investigate all such ways. It is therefore the responsibility of anyone using this manual, to satisfy him or herself completely that neither personal safety or vehicle safety will be jeopardized by the service methods selected. Any such injury or damage is entirely the user's responsibility. This device is not to be used in any manner on the human body.